

# UV CURING



SPECIALIZED LED WORK  
LIGHTS FOR UV CURING

2025

## LED SOLUTIONS FOR FAST UV CURING

// SCANGRIP provides the strongest and most comprehensive range of LED work lights on the market. We are now proud to present a full range of specialized LED solutions for UV curing to perform fast and high-quality curing of any body and paint repair.

The automotive coatings technology is continuously developing new fast cost-effective methods for automotive body and paint repair. Utilizing UV LED curing technology allows you to work faster and more efficiently as the curing time between each operation is reduced significantly. The range of LED solutions for UV curing is applicable for curing of UV cured primers and UV cured body fillers and designed to handle any small or large sized paint repair work.



- Faster curing, only 1 minute through high performance
- Long lifetime > 30.000 hours and low energy consumption
- No heat generation
- Rechargeable products with long operation time



3  
years  
warranty



EU DESIGN  
PATENT  
2954123

## UV-LIGHT

€179.90

03.5801

Flexible, rechargeable LED hand-held work light designed for small and medium cure areas.

Easy to carry in the work belt. Supplied with a turnable sturdy hook and strong built-in magnet for flexible positioning. The shape provides a comfortable, ergonomic grip. Solvent resistant, exchangeable glass lens.

An intelligent battery indicator keeps you informed about the battery level. Supplied with a charging base.

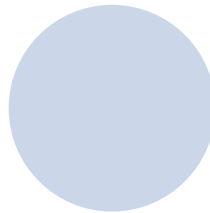

Curing diameter:  $\varnothing 10$  cm  
Minimum Irradiance:  $6\text{mW}/\text{cm}^2$   
Center Irradiance:  $16\text{mW}/\text{cm}^2$   
Operating time: 1.5 hours

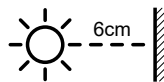

## COLD CURING technology

- // No heat is produced on the panel or the paint during the curing
- // Allows curing of plastic parts or any heat sensitive material
- // Sanding and polishing can be done immediately after the curing is completed



NOVA-UV S

**€ 429.90**

03.5802

Extremely powerful, rechargeable LED flood light with long operation time designed for larger cure areas.

NOVA-UV S is slim and handy with a long operating time. Compared to the previous version, the upgraded NOVA-UV S is now 25 % more powerful, enabling you to either cure the same area faster or increase the distance and cure a larger area at the same speed.

Due to the flexible bracket with strong magnets, NOVA-UV S can be placed in different positions to obtain the desired UV cure angle. The housing is made of sturdy diecasted aluminum and resistant to strokes, shocks and vibrations. Solvent resistant glass lens.



NOVA-UV S is supplied with a built-in timer system 1 to 5 minutes and a battery indicator.

EU DESIGN  
PATENT  
4070035

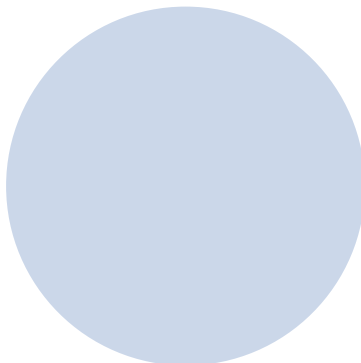

Curing diameter:  $\varnothing 25$  cm  
Minimum Irradiance:  $6\text{mW}/\text{cm}^2$   
Center Irradiance:  $12\text{mW}/\text{cm}^2$

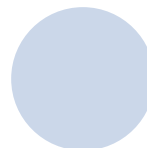
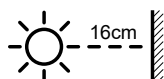

Curing diameter:  $\varnothing 10$  cm  
Minimum Irradiance:  $35\text{mW}/\text{cm}^2$   
Center Irradiance:  $70\text{mW}/\text{cm}^2$

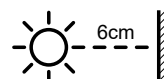

**3**  
years  
warranty



**UV-GUN**  
**€ 1349.90**  
03.5803



UV-GUN is an extremely powerful LED work light for very fast and highly efficient UV curing of large paint repair areas. It provides long operation time and is rechargeable with exchangeable battery.

SCANGRIP has taken advantage of new, high performance battery technologies and invented an innovative concept of flexible and reliable power supply. Easily you can insert a new, fully charged battery and continue the work while another battery is charging.

UV-GUN has been upgraded with a LCD display enabling you to see the remaining battery level and ongoing curing time. With this feature, you will know the exact curing time of each operation and see when it is time to exchange the battery.

Featuring high-quality components and active cooling, UV-GUN has a long lifetime and keeps a high performance level throughout the daily operations. No heat is produced on the panel or the paint during the curing, allowing curing of plastic parts or any heat sensitive material.

UV-GUN is supplied with a solvent resistant glass lens.

**SPS7**  
SCANGRIP POWER SOLUTION



Exchange battery



Supplied with display for battery life and curing time

Curing diameter: ø68 cm  
Minimum Irradiance: 6mW/cm<sup>2</sup>  
Center Irradiance: 14mW/cm<sup>2</sup>

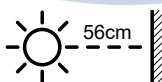

Curing diameter: ø18 cm  
Minimum Irradiance: 68mW/cm<sup>2</sup>  
Center Irradiance: 340mW/cm<sup>2</sup>



Delivered in a practical nylon bag including exchangeable SPS battery, SPS charger and UV protective glasses.

### COMPARISON OF CURING DIAMETER WITH SCANGRIP UV-CURING SOLUTIONS

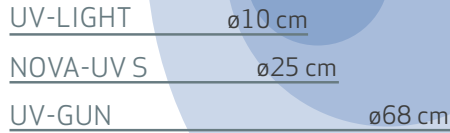

SCANGRIP offers a full range of specialized LED solutions of UV curing to perform fast and high-quality curing of any body and paint repair. Choose your UV curing light solution to fit the size of your paint repair work.



### UV CURING series

	UV-LIGHT	NOVA-UV S	UV-GUN
Product number	03.5801	03.5802	03.5803
Light source	UV LED	UV LED	UV LED
Irradiance	At 6 cm distance Curing diameter: ø10 cm Min. irradiance: 6 mW/cm <sup>2</sup> Center irradiance: 16 mW/cm <sup>2</sup>	At 6 cm distance Curing diameter: ø10 cm Min. irradiance: >35 mW/cm <sup>2</sup> Center irradiance: 70 mW/cm <sup>2</sup>  At 16 cm distance Curing diameter: ø25 cm Min. irradiance: >6 mW/cm <sup>2</sup> Center irradiance: 12 mW/cm <sup>2</sup>	At 10 cm distance Curing diameter: ø18 cm Min. irradiance: >68 mW/cm <sup>2</sup> Center irradiance: 340 mW/cm <sup>2</sup>  At 56 cm distance Curing diameter: ø68 cm Min. irradiance: >6 mW/cm <sup>2</sup> Center irradiance: 14 mW/cm <sup>2</sup>
Curing area	75 cm <sup>2</sup>	75 cm <sup>2</sup> at 6 cm distance 490 cm <sup>2</sup> at 16 cm distance	250 cm <sup>2</sup> at 10 cm distance 3600 cm <sup>2</sup> at 56 cm distance
Wavelength	390-400 nm	395-400 nm	395-400 nm
Operating time with max. lumen	1.5	1.5	40 min
Operating time with min. lumen	-	-	-
Charging time, h	4	3.5	2*
Battery	3.7 V / 2600 mAh	3.7 V / 5400 mAh	11.1 V / 8000 mAh
Protection class	IP30	IP30	IP30
Impact protection	IK07	IK07	IK06
Impact resistance	1 m	1 m	1 m
Cable	1 m USB	1 m USB	5 m / 2 x 0,75 mm <sup>2</sup> H05RN-F
Charging voltage/current DC	5 V / 1 A	5 V / 2 A	12.6 V / 4 A
Power consumption	3 W	12 W	120 W
Battery incl.			SPS BATTERY 03.6004
Charger incl.	No	Yes	SPS CHARGING SYSTEM 50 W 03.6007
Temperature	-10 to +40 °C	-10 to +40 °C	-10 to +40 °C
Dimensions	190 x 60 x 32 mm	163 x 63 x 163 mm	215 x 96 x 300 mm
Net weight	270 g	705 g	1.89 kg incl. battery
Price	<b>€ 179.90</b>	<b>€ 429.90</b>	<b>€ 1349.90</b>



# UV CURING





# ING

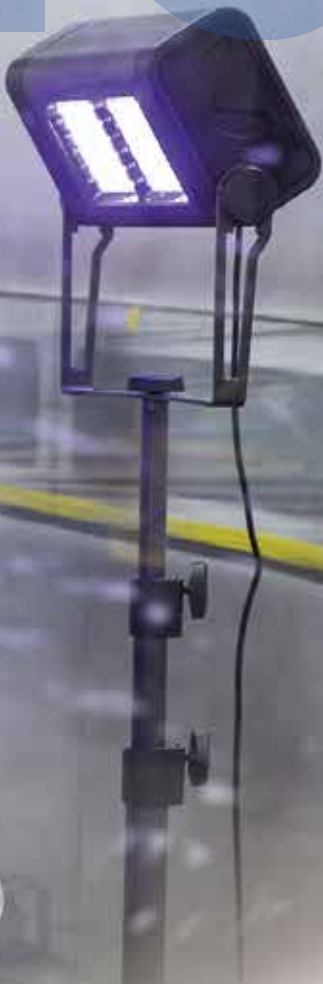

THE WORLD'S MOST  
POWERFUL LIGHTS  
FOR UV CURING

**3**  
years  
warranty

PATENT PROTECTED

# WORLD'S MOST POWERFUL CURING LIGHTS

// SCANGRIP provides the strongest and most comprehensive range of LED work lights on the market. The automotive body and paint repair industry keeps requesting UV solutions capable of curing larger areas faster. To meet this demand, SCANGRIP has now developed 2 new superior, and extremely powerful LED solutions for UV curing to perform fast and high-quality curing of any body and paint repair.

The 2 new UV CURING lights will be more than 3 and 6 times as powerful, respectively, as the present UV lights, and will be the far most powerful UV lights in the world!

- Fast curing of very large areas
- Built-in timer
- Controlled remotely by APP
- No heat generation
- Made in Denmark

## COLD CURING technology

// No heat is produced on the panel or the paint during the curing

// Allows curing of plastic parts or any heat sensitive material

// Sanding and polishing can be done immediately after the curing is completed

The automotive coatings technology is continuously developing new fast cost-effective methods for automotive body and paint repair. Utilizing UV LED curing technology allows you to work faster and more efficiently as the curing time between each operation is reduced significantly. The range of LED solutions for UV curing is applicable for curing of UV cured primers and UV cured body fillers.

ORIGINAL  
SCANGRIP



SINCE 1906

MADE IN DENMARK

3

years  
warranty

PATENT PROTECTED

// Smart and easy operation with user-friendly APP

The built-in BLUETOOTH functionality makes it safe and easy to operate the lamp remotely, even in groups of up to 4 units simultaneously. Using the APP provides safe activation from a distance to avoid being physically close to the UV curing process.



The APP continuously visualizes the remaining curing time.

**Bluetooth®**

BLUETOOTH - Light control app

- Set operating time between 1 and 9 minutes
- Adjust operating time without switching off the lamp
- Grouping of up to 4 units and control as one unit

Compliant with iPhone 5 or higher / Android 5.0 or higher. Go to iTunes App Store to download the app or download the app from scangrip.com



**COMPATIBILITY**

SCANGRIP specialized LED work lights for UV CURING has been tested and proven successfully on leading brands of UV-cured products.



Scan the QR code

**3**  
years  
warranty

PATENT PROTECTED

# UV-EXTREME & UV-EXTREME PLUS

// The 2 new EXTREME curing lights are actively cooled to maximize the UV output with a minimal size of the product.

ORIGINAL  
SCANGRIP



SINCE 1906

MADE IN DENMARK



## UV-EXTREME

€ 2099.90

03.5272

- Extremely powerful LED work light for very fast and highly efficient UV curing of large paint repair areas, up to approximately 100 x 100 cm.

Curing diameter:  $\varnothing$  22 cm  
Min. irradiance:  $>80$  mW/cm<sup>2</sup>  
Center irradiance: 395 mW/cm<sup>2</sup>  
Curing area: 380 cm<sup>2</sup>

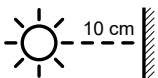

Curing diameter:  $\varnothing$  90 cm  
Min. irradiance:  $>6$  mW/cm<sup>2</sup>  
Center irradiance: 35 mW/cm<sup>2</sup>  
Curing area: 6300 cm<sup>2</sup>

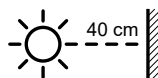

Curing diameter:  $\varnothing$  95 cm  
Min. irradiance:  $>6$  mW/cm<sup>2</sup>  
Center irradiance: 16 mW/cm<sup>2</sup>  
Curing area: 7000 cm<sup>2</sup>

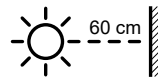

The 2 UV-EXTREME work lights are packed in sturdy and high-quality cases that can withstand shocks and rough handling during shipment. The cases have a built-in handle. When the lights are not in use, the transport case can be used to store the lamp.

3  
years  
warranty

PATENT PROTECTED

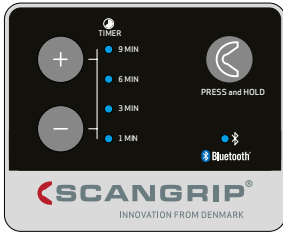

Built-in timer and Bluetooth



**Bluetooth®**

**BLUETOOTH - Light control app**

- Set operating time between 1 and 9 minutes
- Adjust operating time without switching off the lamp
- Grouping of up to 4 units and control as one unit

Compliant with iPhone 5 or higher / Android 5.0 or higher. Go to iTunes App Store to download the app or download the app from scangrip.com



**UV-EXTREME PLUS**

**€3149.90**

03.5273



Superior and most powerful LED work light in the world for very fast and highly efficient UV curing of larger paint repair areas, up to 135 x 130 cm, equivalent to the size of a car door.

Curing size: 34 x 24 cm  
Min. irradiance: >120mW/cm<sup>2</sup>  
Center irradiance: 490mW/cm<sup>2</sup>  
Curing area: 640 cm<sup>2</sup>

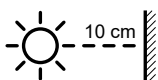

Curing size: 110 x 100 cm  
Min. irradiance: >6 mW/cm<sup>2</sup>  
Center irradiance: 68 mW/cm<sup>2</sup>  
Curing area: 8600 cm<sup>2</sup>

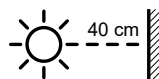

Curing size: 135 x 130 cm  
Min. irradiance: >6 mW/cm<sup>2</sup>  
Center irradiance: 18 mW/cm<sup>2</sup>  
Curing area: 13000 cm<sup>2</sup>

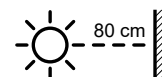

# FLEXIBLE POSITIONING ON WHEEL STAND



## SCANGRIP WHEEL STAND

€ 169.90

03.5682

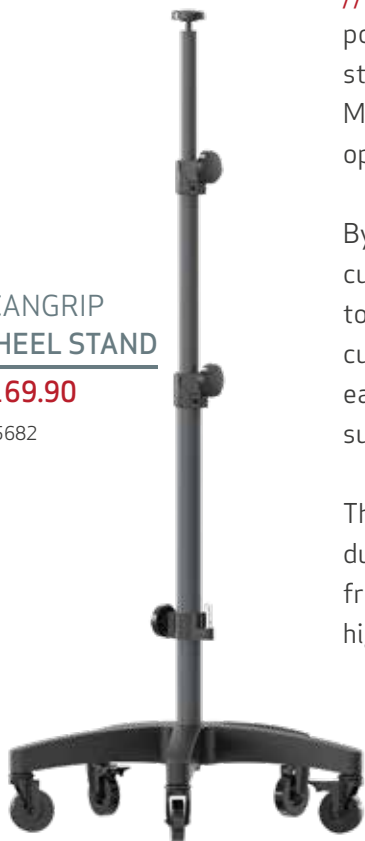

// The SCANGRIP WHEEL STAND will be the perfect stand for the 2 extremely powerful curing lights. You will be able to mount the work light on top of the stand and position the light in the requested height (1260-2300 mm). Mounted in the bracket you will also be able to adjust the angle to obtain optimum curing effect on the subject to be cured.

By the app you will be able to control the curing proces remotely and do not have to be close to the UV irradiance. When the curing process is finished it is fast and easy to move it aside to make room for the subsequent repair work.

The WHEEL STAND is a very stable and durable construction easy to move around from job to job. The 5-wheel base ensures high stability and easy maneuverability.

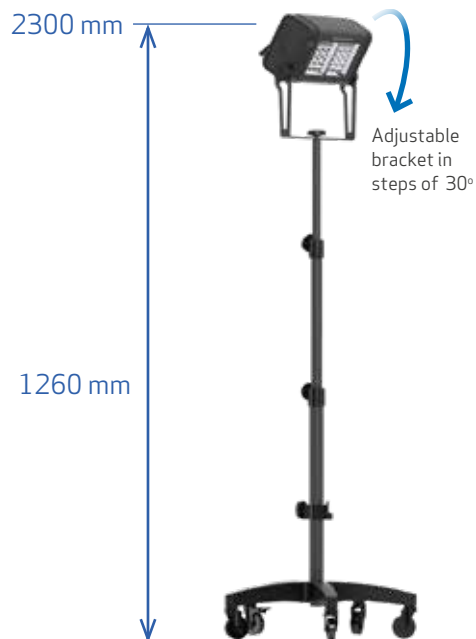

## MOUNTING BRACKET for UV-EXTREME

€ 49.90

03.5915



// Sometimes it is necessary to cure on lower parts of the vehicle or on the side, for instance. For this purpose we recommend to use the bracket of the WHEEL STAND center bar which is adjustable in the height (380-895 mm). To fix the UV-EXTREME or UV-EXTREME PLUS at the lower part of the WHEEL STAND you need this additional MOUNTING BRACKET as accessory.

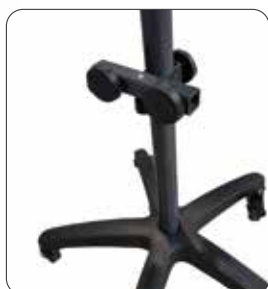



	UV-EXTREME	UV-EXTREME PLUS
Product number	03.5272	03.5273
Light source	UV LED	UV LED
Irradiance	<p>At 60 cm distance Curing diameter: ø 95 cm Min. irradiance: &gt;6 mW/cm<sup>2</sup> Center irradiance: 16 mW/cm<sup>2</sup></p> <p>At 40 cm distance Curing diameter: ø 90 cm Min. irradiance: &gt;6 mW/cm<sup>2</sup> Center irradiance: 35 mW/cm<sup>2</sup></p> <p>At 10 cm distance Curing diameter: ø 22 cm Min. irradiance: &gt;80 mW/cm<sup>2</sup> Center irradiance: 398 mW/cm<sup>2</sup></p>	<p>At 80 cm distance Curing size: 135x130 cm Min. irradiance: &gt;6 mW/cm<sup>2</sup> Center irradiance: 18 mW/cm<sup>2</sup></p> <p>At 40 cm distance Curing size: 110x100 cm Min. irradiance: &gt;6 mW/cm<sup>2</sup> Center irradiance: 68 mW/cm<sup>2</sup></p> <p>At 10 cm distance Curing size: 34x24 cm Min. irradiance: &gt;120mW/cm<sup>2</sup> Center irradiance: 490mW/cm<sup>2</sup></p>
Curing area	<p>7000 cm<sup>2</sup> at 60 cm distance 6300 cm<sup>2</sup> at 40 cm distance 380 cm<sup>2</sup> at 10 cm distance</p>	<p>13000cm<sup>2</sup> at 80 cm distance 8600cm<sup>2</sup> at 40 cm distance 640cm<sup>2</sup> at 10 cm distance</p>
Wavelength	395-400nm	395-400nm
Protection class	IP30	IP30
Impact protection	IK08	IK08
Impact resistance	1 m	1m
Cable	5 m / 2 x 1.0 mm <sup>2</sup> H05RN-F	5 m / 2 x 1.0 mm <sup>2</sup> H05RN-F
Operating voltage AC	220-240 V	220-240 V
Charging voltage/current DC	-	-
Power consumption	300 W	600 W
Temperature	-10° to +40 °C	-10° to +40 °C
Dimensions	278 x 241 x 160 mm	415 x 241 x 160 mm
Net weight	4.95 kg	6.70 kg
Price	<b>€ 2099.90</b>	<b>€ 3049.90</b>

Verified UV protection face visor is included

RISK GROUP 3



// SCANGRIP is Europe's leading manufacturer of work lights for professionals providing the strongest and most comprehensive ranges of work lights with the latest LED lighting technology available on the market.

SCANGRIP is innovation from Denmark and receives strong recognition in the marketplace for its product design, and the products are known for their high quality.

SCANGRIP strives for perfection, and is continuously optimizing and improving light output, battery capacity, design and ergonomics, durability, user-friendliness, and functionality. The aim is to set new standards for professional work lights.

SCANGRIP was established in 1906 and has a long, impressive history of manufacturing high-quality hand tools and work lights for the industrial, construction, and automotive sectors.

SCANGRIP is part of Hultafors Group - a global company offering a unique portfolio of premium brands within personal protection, tools, and other equipment for discerning craftsmen. Together, we are on a mission to create a better day for professional users.